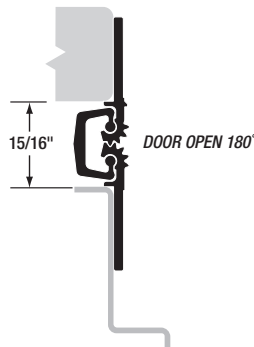
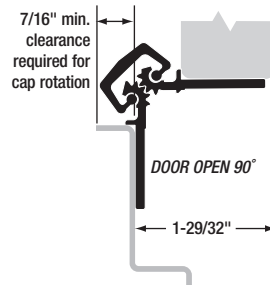
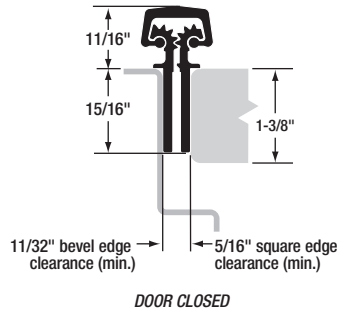

SL38 Concealed Geared Continuous Hinge

MATERIAL: Extruded 6063 T6 aluminum alloy with self-lubricating polyester thrust bearings.

LENGTHS: 83" and 95" lengths standard for nominal door heights. Hinges can be cut to shorter lengths. Longer hinges are not available.

LOAD/FREQUENCY RATING: For 1" to 1-3/8" doors. 48" max. door width in 16 gauge hollow metal (min.) or 1/8" aluminum (min.).

Standard Duty – Tested per BHMA standards for medium-frequency doors up to 200 lb. without frame or door reinforcement.

FINISHES: All SL38 hinges are stocked in Clear and Dark Bronze anodized aluminum. Custom anodized or painted finishes are available. Product painted or anodized in the field voids the SELECT hinge warranty.

CLOSERS: Conventional overhead surface, concealed sliding arm overhead or floor closers may be used with SELECT hinges. Pivot-type floor closers (with a fixed, conflicting center pivot) must be replaced.

ORDER: Specify length, finish and standard duty (SD). Also, specify door and frame screw applications. 12-24 x 3/4" self-drilling, thread-forming 410SS Phillips undercut flathead screws are provided as a standard pack unless otherwise specified. Wood and thread-forming screws also available. Security screws optional at extra cost.

AVAILABLE ELECTRIC PREPS: EMS, CMG, AP and RP.

SL38 HINGE SCREW COUNT

HINGE LENGTH & DUTY RATING	DOOR SCREWS	FRAME SCREWS
83" SD	11	11
95" SD	11	11

SPECIFICATIONS

SL38 Concealed Geared Continuous Hinge



SELECT ADVANTAGES

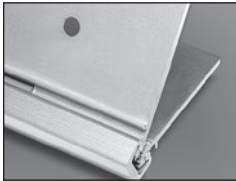

PAIR-MATCHED™ HINGE LEAVES

Manufactured together, machined together and anodized together, making SELECT hinges fit your doors better and last longer. An exclusive SELECT benefit.

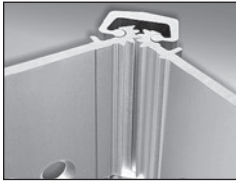

LIFETIME LUBRICATION

Eliminates the need for periodic maintenance. Quiet performance. Fights gear cap wear. An exclusive SELECT benefit.



ANODIZED AFTER MACHINING

Delivers superior wear, durability and life. Inhibits corrosion. Few hinge makers follow SELECT's lead in using this superior manufacturing process.



MEETS LEED REQUIREMENTS

Made from recycled aluminum. Reduces environmental impact and qualifies for LEED points. An exclusive SELECT benefit.

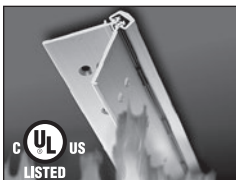

PATENTED 3-HR. FIRE RATING

Most SELECT hinges are fire rated for 90 minutes. 3-Hr. fire rating, optional at extra cost, approved for positive/negative pressure. No fire pins or studs required. Patented design innovation. An exclusive SELECT benefit.

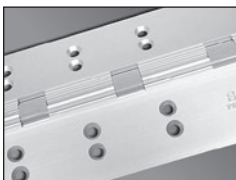

CONSISTENT TEMPLATING

Hole pattern is identical on both Standard and Heavy Duty models, so SELECT hinges line up precisely for easier and faster installation. An exclusive SELECT benefit.



COATED FASTENERS

Provide additional corrosion protection with either self-drilling, thread-forming (SDTF) or thread-forming (TF) screws. An exclusive SELECT benefit.



CUSTOM COLORS

Match any paint color on the gear cap or the entire hinge and fasteners, including our always-in-stock Bone White gear caps. Anodized colors also available.

SELECT HINGE PERFORMANCE

- A SELECT geared continuous hinge has been tested in accordance with ANSI 250.4-1994 test procedure and acceptance criteria for physical endurance for steel doors and hardware and has surpassed 25,000,000 cycles during testing by an independent laboratory. On a door cycling 400,000 times per year, a SELECT hinge will be performing for over 62 years.
- SELECT geared continuous hinges are built to handle abuse from high-traffic applications. They are applied to the surface on the edge of the frame and door. No machining or reinforcement is required.
- The revolutionary SELECT geared continuous hinge puts an end to costly and irritating hinge failure problems, the most common cause of entrance failure.
- On conventional hinges, opening and “kick-back” energy concentrate on a few inches of fastened reinforcing plate — with the top hinge handling 100% of the force. Pinless SELECT hinges bond the door and frame into an integrated, sag-free unit. “Kick-back” energy dissipates along the entire length of the door and frame. (Compare this to a conventional hinge’s 4-1/2" to 5" at the top of the door and frame).
- SELECT geared continuous hinges eliminate the gap between the door and frame, providing a weatherproof, rust-proof, tamper-proof barrier. When the door is closed, there are no accessible screws, bolts or pins.
- SELECT SL38 geared continuous hinges are listed and tested by Underwriters Laboratories to meet the Positive and Negative pressure requirements of UL10B and UL10C, and are in accordance with UBC 7.2 (1997). SELECT SL38 geared continuous hinges are for use on swinging single fire doors (max. door opening of 4'x10') or pairs of fire doors (max. door opening of 8'x10'), including double egress, installed in masonry or drywall. SELECT SL38 geared continuous hinges are rated for up to 1-1/2 hours for wood composite and wood core type fire doors.