

# CUSTOM SCRM4550 DOUBLE-LIPPED STRIKE & RESCUE STOP COMBO

- 1-3/4" THICK DOOR
- 1/8" INSET DOOR
- SCHLAGE MORTISE LOCK W / DEAD BOLT
- 8-1/2" FRAME

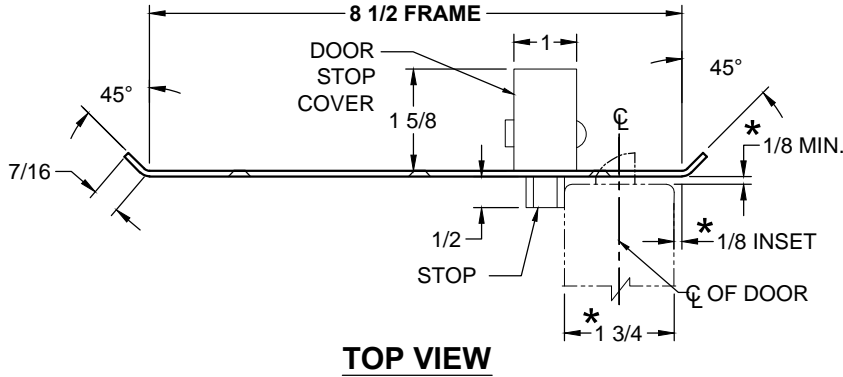

STOP IS SPRING LOADED  
MAKING PART NON-HANDED  
BUT INSTALLATION IS  
STILL HANDED

**ABH DOOR STOP COVER DIMENSIONS  
MAY NOT MATCH OTHER  
MANUFACTURERS**

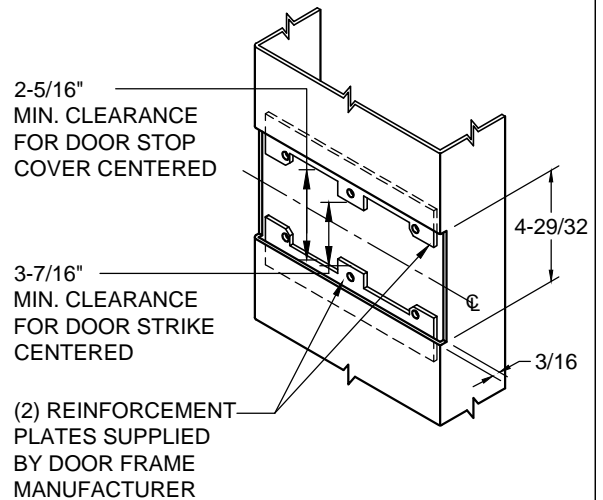
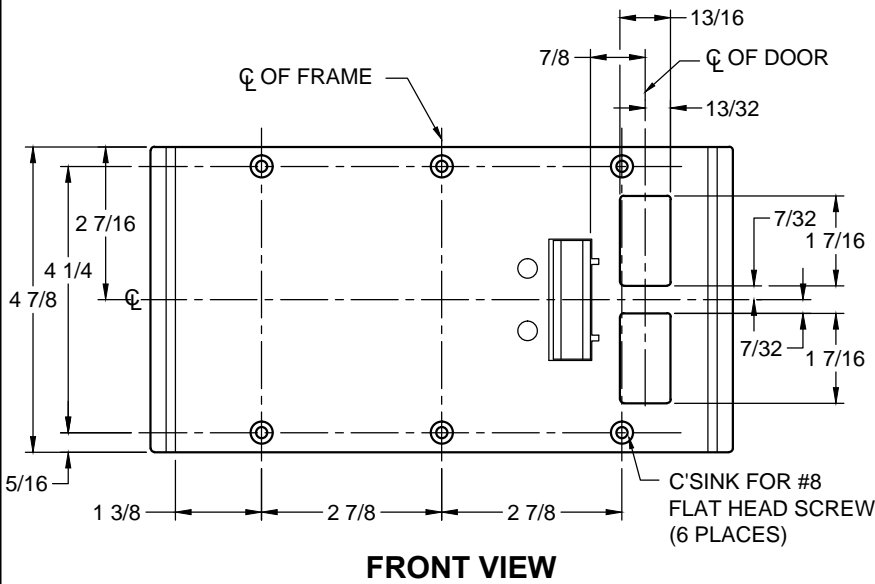

**NOTE:**

1. HORIZONTAL CENTERLINE OF PLATE TO MATCH HORIZONTAL CENTERLINE OF CUT-OUT.
2. SCREWS- 8-32 X 3/8" UNDERCUT F.H.M.S.
3. R.H. DOOR SHOWN, L.H. OPPOSITE
4. DO NOT SCALE DRAWING.
5. FOR CUSTOM RESCUE DOOR STOP CONSULT FACTORY.

**REINFORCEMENT:**

WHEN INSTALLING IN METAL FRAME, REINFORCEMENT IS **NEEDED** WITH THIS PRODUCT, CUSTOMER OR MANUFACTURER TO SUPPLY FRAME REINFORCEMENT WITH LATCH BOLT CLEARANCE.

\* = CRITICAL DIMENSION MUST BE FOLLOWED



www.abhmfg.com  
E-mail: abhinfo@abhmfg.com  
Architectural Builders Hardware Mfg., Inc.  
1222 Ardmore Ave., Itasca, IL 60143  
630.875.9900; FAX 800.9FAXABH (932.9224)

SP-CR4538 8.500x4.875 SCHLAGE.DWG

**SP-CR4538**

©2016 ABH Mfg., Inc.  
printed in USA

ISSUED 12-6-16