

CUSTOM SCRM4550 DOUBLE-LIPPED STRIKE & RESCUE STOP COMBO

- 1-3/4" THICK DOOR
- 1/8" INSET DOOR
- SCHLAGE MORTISE LOCK W / DEAD BOLT
- 10-3/8" FRAME

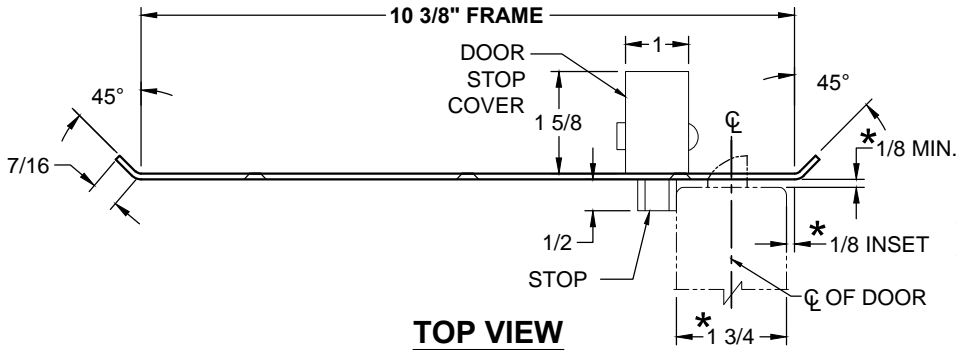

STOP IS SPRING LOADED
MAKING PART NON-HANDED
BUT INSTALLATION IS
STILL HANDED

**ABH DOOR STOP COVER DIMENSIONS
MAY NOT MATCH OTHER
MANUFACTURERS**

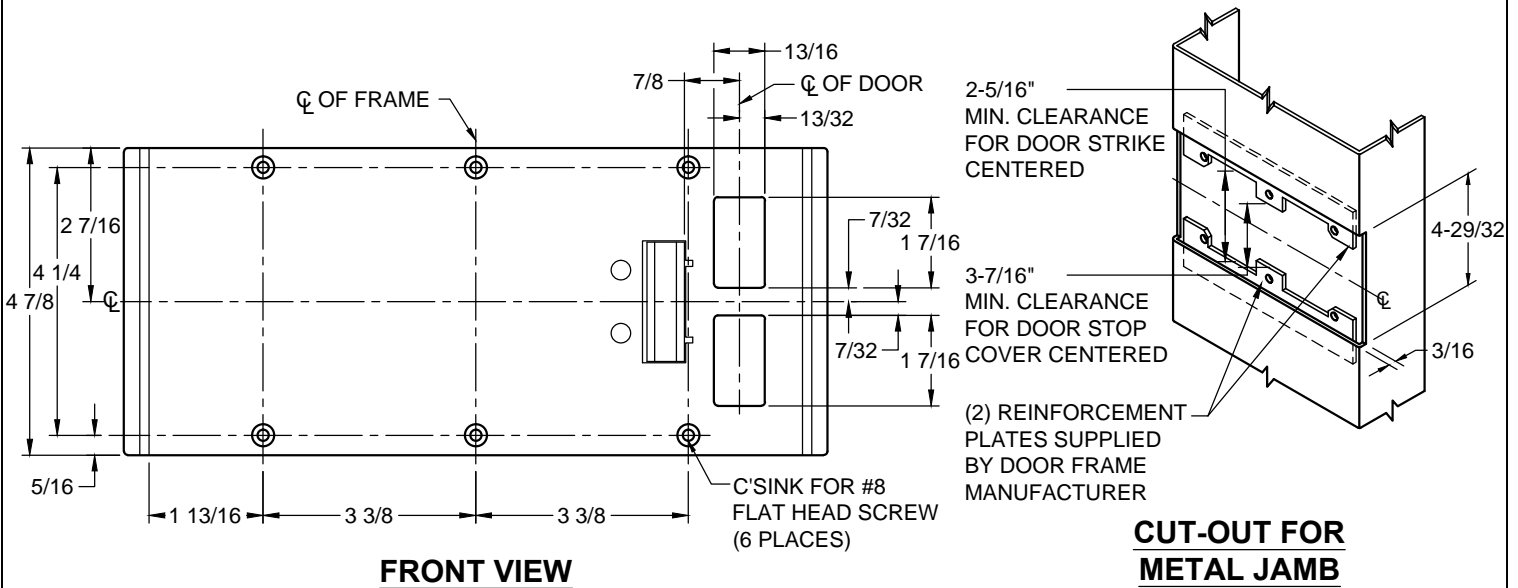

NOTE:

1. HORIZONTAL CENTERLINE OF PLATE TO MATCH HORIZONTAL CENTERLINE OF CUT-OUT.
2. SCREWS - 8-32 x 3/8" UNDERCUT F.H.M.S.
3. R.H. DOOR SHOWN, L.H. OPPOSITE
4. DO NOT SCALE DRAWING.
5. FOR CUSTOM RESCUE DOOR STOP CONSULT FACTORY.

REINFORCEMENT:

WHEN INSTALLING IN METAL FRAME, REINFORCEMENT IS **NEEDED** WITH THIS PRODUCT, CUSTOMER OR MANUFACTURER TO SUPPLY FRAME REINFORCEMENT WITH LATCH BOLT CLEARANCE.

* = CRITICAL DIMENSION MUST BE FOLLOWED



www.abhmfg.com
E-mail: abhinfo@abhmfg.com
Architectural Builders Hardware Mfg., Inc.
1222 Ardmore Ave., Itasca, IL 60143
630.875.9900; FAX 800.9FAXABH (932.9224)

SP-CR4557 10.375x4.875 SCHLAGE.DWG

SP-CR4557

©2016 ABH Mfg., Inc.
printed in USA

ISSUED 12-19-16