

# SP-CR743 CUSTOM DOUBLE LIPPED STRIKE AND RESCUE STOP

FOR 1-3/4" DOOR, 1/8" INSET, CYLINDRICAL LATCH, 12-1/8" FRAME

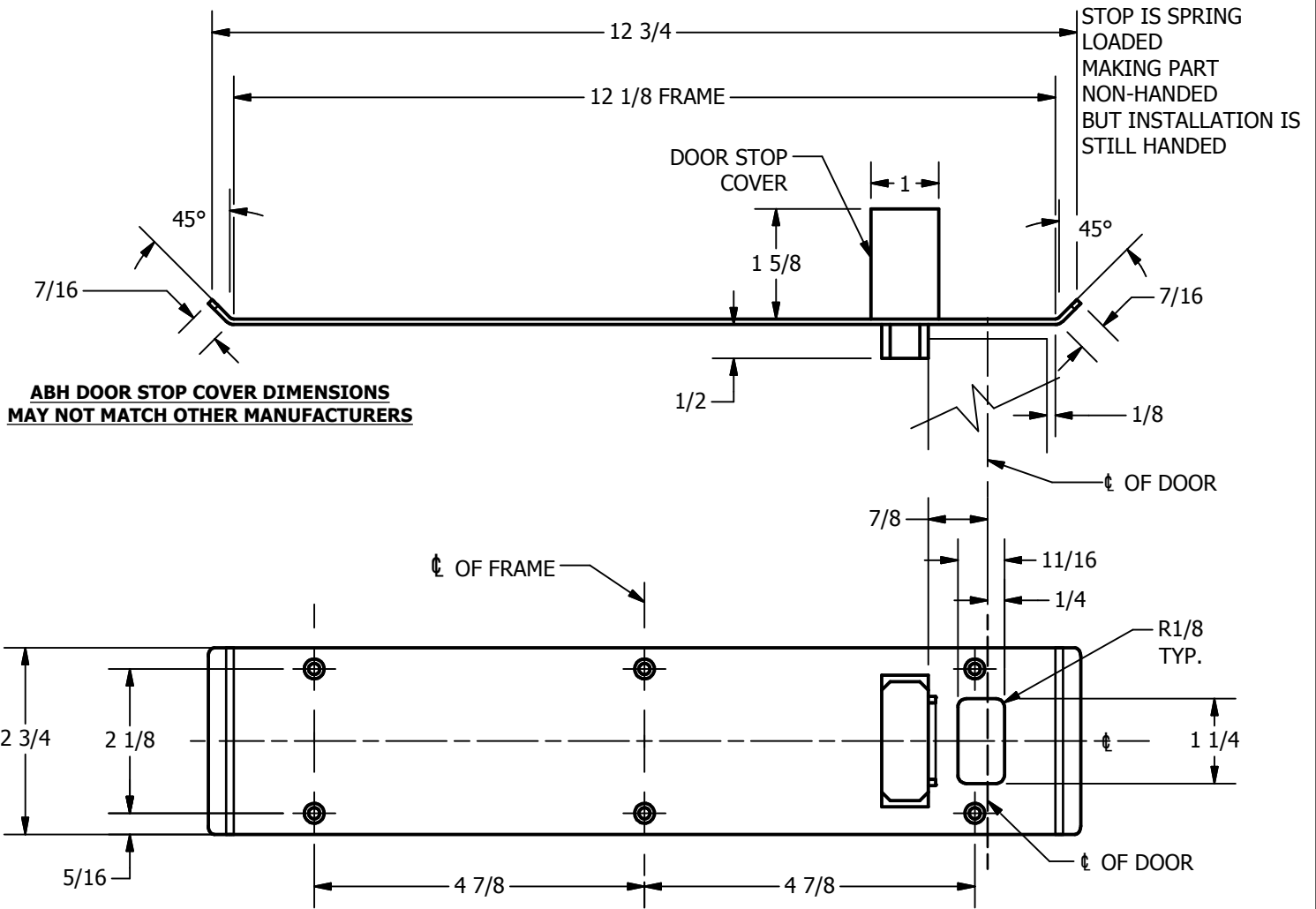

**ABH DOOR STOP COVER DIMENSIONS MAY NOT MATCH OTHER MANUFACTURERS**

**REINFORCEMENT:**

WHEN INSTALLING IN METAL FRAME, REINFORCEMENT IS **NEEDED** WITH THIS PRODUCT, CUSTOMER OR MANUFACTURER TO SUPPLY FRAME REINFORCEMENT WITH LATCH BOLT CLEARANCE

2-5/16  
MIN. CLEARANCE  
FOR DOOR STOP COVER  
CENTERED

1-1/2  
MIN. CLEARANCE  
FOR DOOR STRIKE  
CENTERED

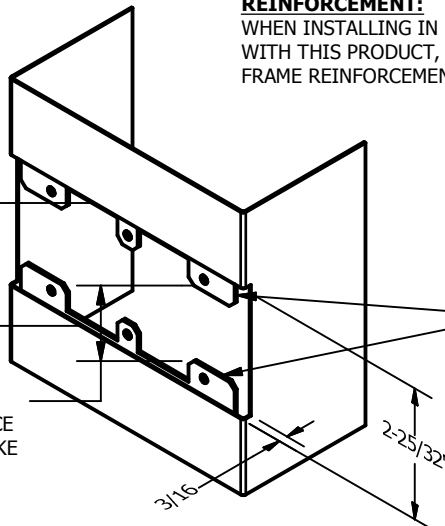

(2) REINFORCEMENT PLATES  
SUPPLIED BY DOOR FRAME  
MANUFACTURER

**NOTE:**

1. HORIZONTAL CENTERLINE OF PLATE TO MATCH HORIZONTAL CENTERLINE OF CUTOUT.
2. SCREWS 8-32 X 3/8" UNDERCUT F.H.M.S.
3. R.H. DOOR SHOWN, L.H. OPPOSITE

ORDER #: \_\_\_\_\_  
 ORDER DATE: \_\_\_\_\_  
 CUSTOMER: \_\_\_\_\_  
 CUSTOMER PO#: \_\_\_\_\_  
 MATERIAL: \_\_\_\_\_  
 QUANTITY: \_\_\_\_\_

**CUT-OUT FOR  
METAL JAMB**

**Architectural Builders Hardware Mfg., Inc.**

1222 Ardmore Ave., Itasca, IL 60143  
 630.875.9900; FAX 800.9FAXABH (932.9224)

www.abhmfg.com  
 Email: abhinfo@abhmfg.com