

# SP-CR768 CUSTOM DOUBLE LIPPED STRIKE AND RESCUE STOP

FOR 1-3/4" DOOR, 1/8" INSET, MORTISE LOCK, NO DEADBOLT, 7-1/2" FRAME

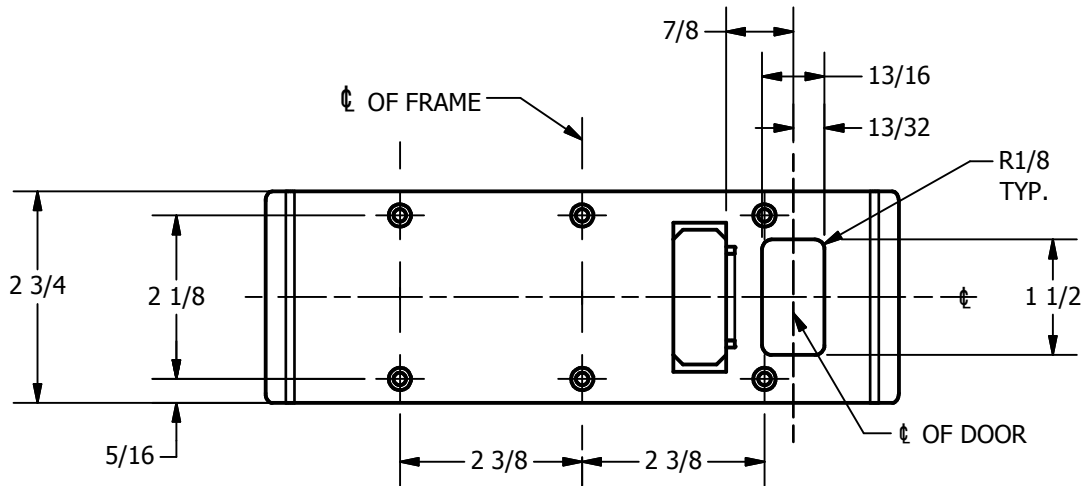
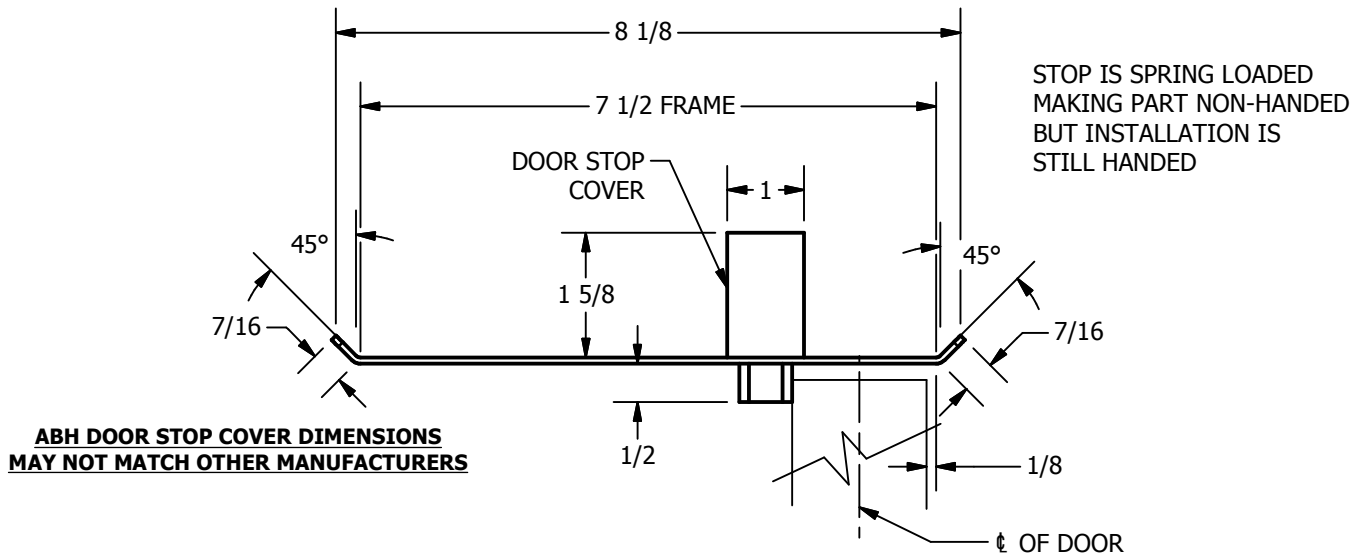

**REINFORCEMENT:**

WHEN INSTALLING IN METAL FRAME, REINFORCEMENT IS **NEEDED** WITH THIS PRODUCT, CUSTOMER OR MANUFACTURER TO SUPPLY FRAME REINFORCEMENT WITH LATCH BOLT CLEARANCE

2-5/16  
MIN. CLEARANCE  
FOR DOOR STOP COVER  
CENTERED

1-1/2  
MIN. CLEARANCE  
FOR DOOR STRIKE  
CENTERED

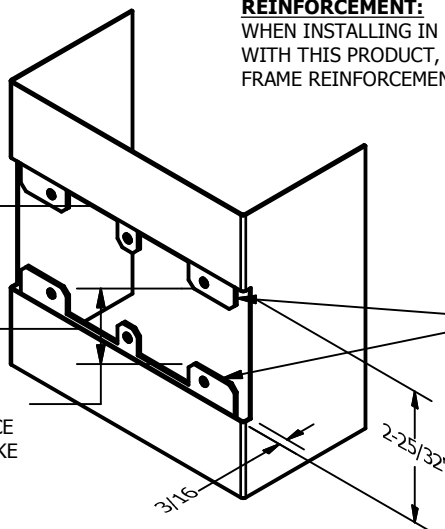

**CUT-OUT FOR METAL JAMB**

**NOTE:**

1. HORIZONTAL CENTERLINE OF PLATE TO MATCH HORIZONTAL CENTERLINE OF CUTOUT.
2. SCREWS 8-32 X 3/8" UNDERCUT F.H.M.S.
3. R.H. DOOR SHOWN, L.H. OPPOSITE

ORDER #: \_\_\_\_\_

ORDER DATE: \_\_\_\_\_

CUSTOMER: \_\_\_\_\_

CUSTOMER PO#: \_\_\_\_\_

MATERIAL: \_\_\_\_\_

QUANTITY: \_\_\_\_\_

**Architectural Builders Hardware Mfg., Inc.**

1222 Ardmore Ave., Itasca, IL 60143  
630.875.9900; FAX 800.9FAXABH (932.9224)

www.abhmfg.com

Email: abhinfo@abhmfg.com