

**SP-DS5303 CUSTOM DOUBLE LIPPED STRIKE**  
 FOR 1-3/4" DOOR WITH 1/8" INSET, 11-7/8" FRAME, MORTISE LOCK, NO DEADBOLT

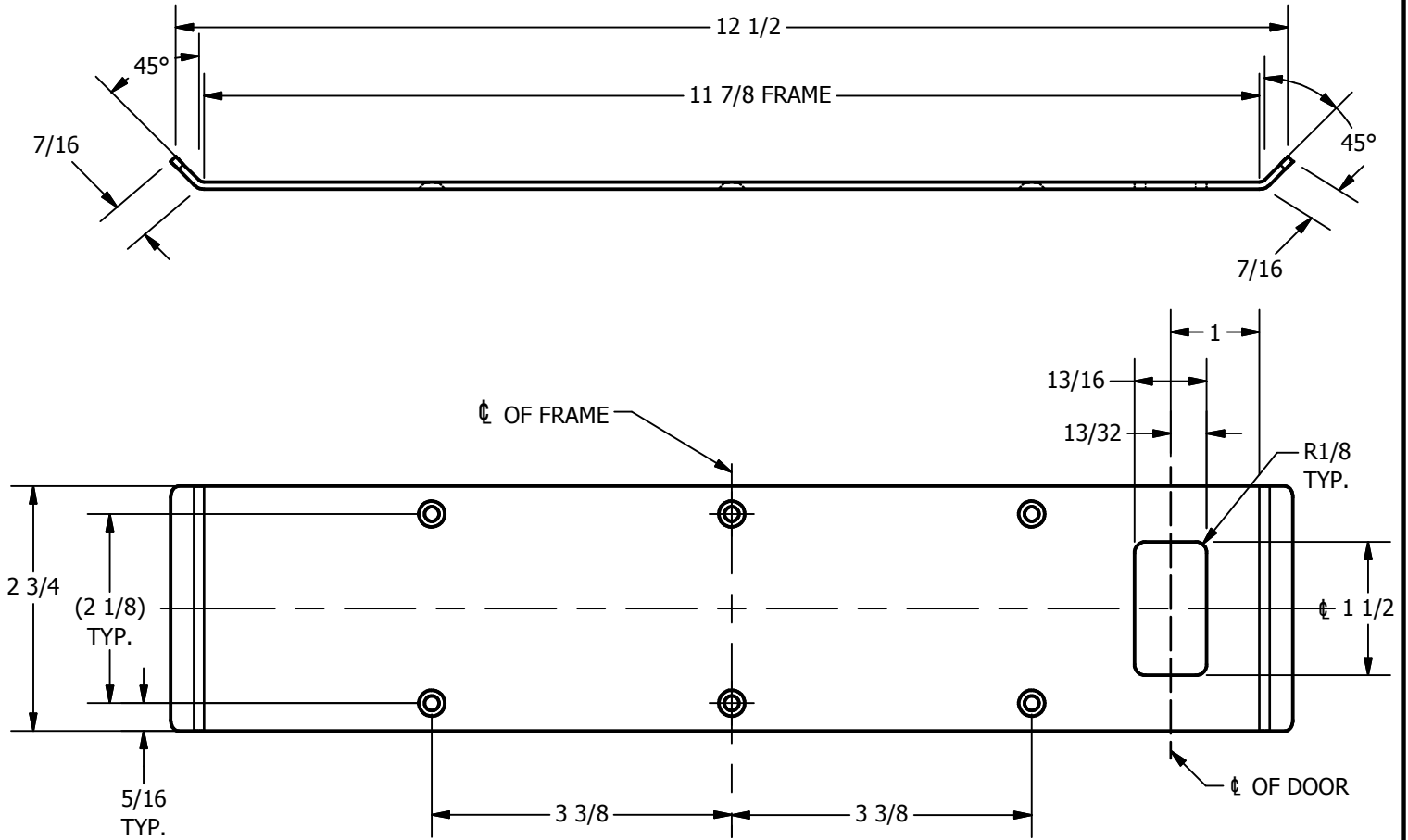

**REINFORCEMENT:**  
 WHEN INSTALLING IN METAL FRAME, REINFORCEMENT IS **NEEDED**  
 WITH THIS PRODUCT, CUSTOMER OR MANUFACTURER TO SUPPLY  
 FRAME REINFORCEMENT WITH LATCH BOLT CLEARANCE

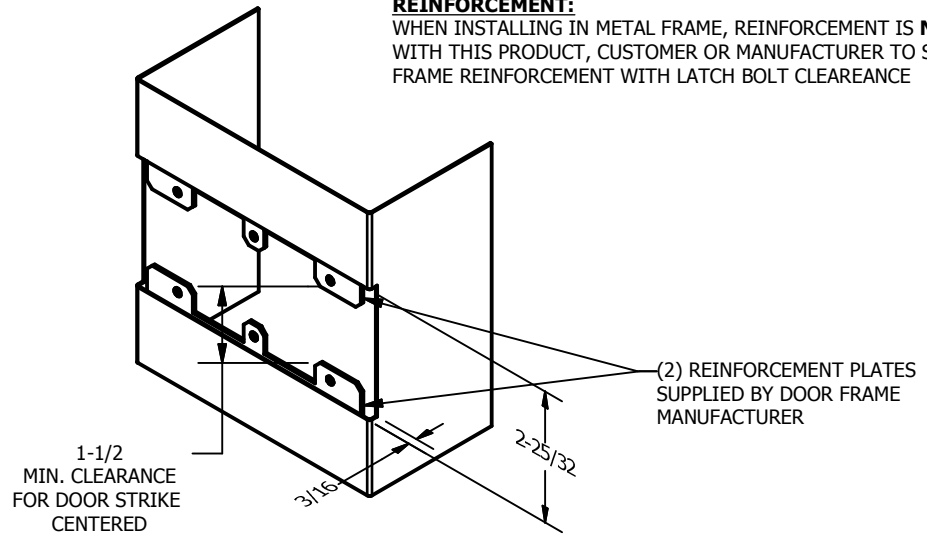

**CUT-OUT FOR  
 METAL JAMB**

- NOTE:**
1. HORIZONTAL CENTERLINE OF PLATE TO MATCH HORIZONTAL CENTERLINE OF CUTOUT.
  2. SCREWS 8-32 X 3/8" UNDERCUT F.H.M.S.
  3. R.H. DOOR SHOWN, L.H. OPPOSITE

ORDER #: \_\_\_\_\_  
 ORDER DATE: \_\_\_\_\_  
 CUSTOMER: \_\_\_\_\_  
 CUSTOMER PO#: \_\_\_\_\_  
 MATERIAL: \_\_\_\_\_  
 QUANTITY: \_\_\_\_\_

**Architectural Builders Hardware Mfg., Inc.**

1222 Ardmore Ave., Itasca, IL 60143  
 630.875.9900; FAX 800.9FAXABH (932.9224)  
 www.abhmfg.com  
 Email: abhinfo@abhmfg.com