

## TROUBLESHOOTING

Possible Trouble	Probable Cause	Suggested Remedy
Door lockset is not secured by Electric Strike	1) Centerline of lockset is not properly aligned to the centerline of the electric strike.	Check for proper cutout installation of Electric Strike by referring to template and door frame and lockset position.
	2) Latch does not project properly into the cavity of the electric strike	Check for excessive gap between door and jamb. Check that lockset is compatible with EN series cavity and requirements. If necessary, use other type of lockset or Electric Strike (refer to Trine Catalog for more information).
	3) Latch Spring broken or missing	Hold Electric Strike so that wiring faces down and apply pressure to Latch. Verify that Latch releases and that there is sufficient Spring tension to push it to closed position when released. If Latch does not have Spring tension, disassemble Electric Strike and inspect for improperly installed or broken Spring.

Electric Strike does not energize (activate)	1) Wiring to electric strike is open or shorted.	Check that electrical connections are secure and that no fraying has occurred during installation. Use voltmeter to verify that Electric Strike is receiving energizing voltage and that wiring is not shorted.
	2) Insufficient voltage to electric strike.	Verify that voltage rating on Electric Strike label is compatible with voltage from secondary transformer (12V or 24V). If voltages do not match, either replace transformer or change Electric Strike or Coil Assembly.  Use voltmeter to verify that Electric Strike is receiving proper voltage and that wiring is not shorted.  If voltage is too low because wire size is too small for length or wiring to Electric Strike (see wiring-length data on previous page), either replace wiring or use transformer with higher VA rating.
	3) Slider does not move when coil receives proper voltage	Using an OHM meter, verify that resistance of the Coils matches the chart on page 3. If Coil is open (burned out), verify that transformer for Electric Strike has correct voltage current AC/DC and is wired correctly. AC Coils do not operate at continuous duty, or on DC voltage.  Check that Slider (2) floats freely, as follows:  Remove Electric Strike from jamb and hold with wires facing up. Test that Strike is locked by applying pressure to Latch. Then turn Strike upside down with wires facing down and verify that Latch opens freely by applying pressure. The locking Slider (#2) must float freely for unit to operate properly.

Electric Strike energizes but does not disengage the lockset	1) Lockset is applying pressure to electric strike, preventing latch from releasing.	Check for proper cutout installation of Electric Strike. Latch requires proper clearance to open correctly and provide path for Lockset Latch to engage Strike.  Check that Lockset Latch is not binding to bottom of Strike cavity due to door sag.  Check if foam insulation or the materials around door jamb are preventing door from closing flush, causing door to put pressure on Latch.
--	--	---

**FOR ADDITIONAL INFORMATION, HELP, ACCESS TO SPECS ON A OUR FULL LINE OF PRODUCTS, OR ADDITIONAL CONTACT OPTIONS PLEASE VISIT OUR WEBSITE**

**www.trineonline.com**

V. 18.0104



PHONE: (203) 730-1756  
FAX: (203) 730-1781  
2 PARKLAWN DRIVE, BETHEL, CT 06801  
email: customerservice@trineonline.com  
website: www.trineonline.com

# EN800 & EN850 ELECTRIC STRIKE



## INSTALLATION INSTRUCTIONS

Congratulations on the purchase of this quality TRINE security product. This product has been designed to install easily, perform reliably, and provide years of trouble free security.

BEFORE proceeding with your installation, please review the following list of features. If you have any questions after reading this document please call TRINE's TECHNICAL SUPPORT (203) 730-1756 EXT. 447, or visit the TRINE web site at [www.trineonline.com](http://www.trineonline.com)

### PARTS LIST

Index No.	Name Part	Number
1	EN800-850 Latch	EN-PLCH
2	Slider	EN-SLR
3	Coil Assembly (12V)	EN-CA-12DC or EN-CA-12AC
	Coil Assembly (24V)	EN-CA-24DC or EN-CA-24AC
4	Screws (2) #4-40 x 1/8" (Cover)	EN-SCR 1/8
5	Frame Cover	EN-FR.C
6	Screws #4-40 x 1/4" (Coil)	EN-SCR 1/4
7	Frame **	EN-FR400
8	Assembly Pin*	EN-ASS.PN
9	Spring	EN-SPR
10	Latch Pivot Pin	EN-LCH-PV-ST
11	Slider Guard	EN-GRD
12	800 Faceplate	EN-800-FACE
	850 Faceplate	EN-850-FACE
13	Mounting Screws (2)	EN-800-MTS
	Mounting Screws (2)	EN-850-MTS

NOTE: Numbers in parenthesis ( ) indicates part in Parts List.

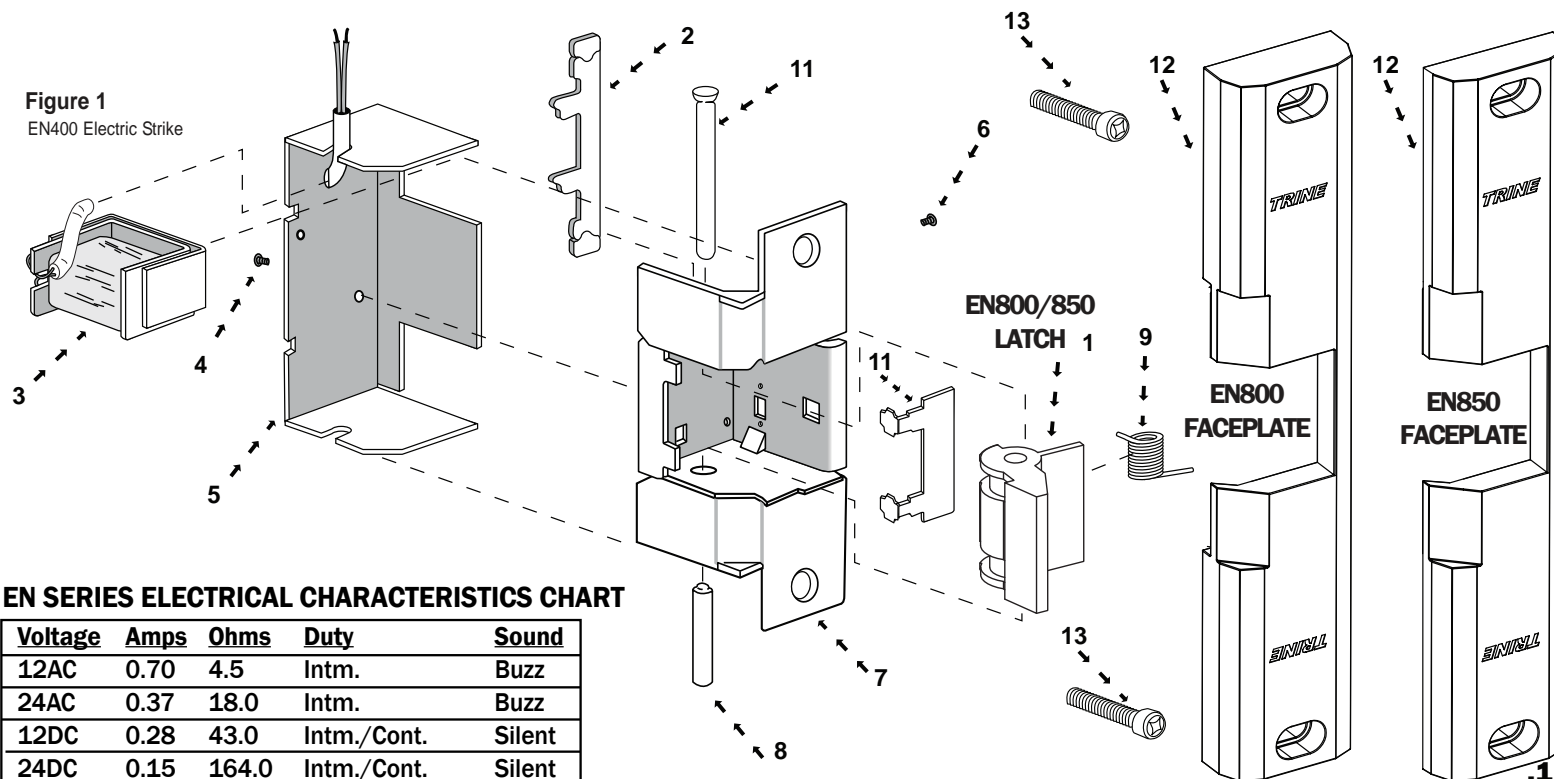

### EN SERIES ELECTRICAL CHARACTERISTICS CHART

Voltage	Amps	Ohms	Duty	Sound
12AC	0.70	4.5	Intm.	Buzz
24AC	0.37	18.0	Intm.	Buzz
12DC	0.28	43.0	Intm./Cont.	Silent
24DC	0.15	164.0	Intm./Cont.	Silent



UL LISTED - 1034 Burglary Resistant Locking Mechanism for Indoor or Outdoor Use

UL LISTED - 294 Access Control System Units

ANSI/BHMA - A156.5 - 1992 - 4-7/8" x 1-1/4" Fits Cutout Specification A115.1 (with Slight Jamb Modification)

BHMA - Grade 1

All models have been evaluated for the following performance levels per UL 294 6th edition:

Destructive Attack	Access Control Line Security	Endurance	Standby Power
I	I	IV	I

Listed Class 2 Power-limited burglary power supply

OPERATING TEMP RANGE: -20°C TO +40°C

**DOOR HANDING GUIDE**

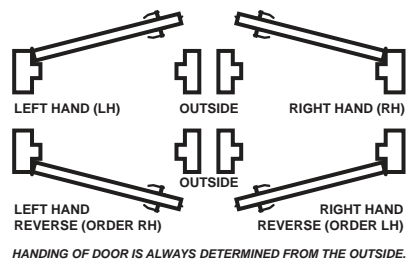

**HANDING DETERMINATION**

Door handing is determined by the position of the hinges, as viewed from the outside of the room or building. If the door hinges are on the left, the door is termed left handed; if the door hinges are on the right, the door is termed right handed. Also a door is either inswinging (opens into the room), or outswinging (opens to the outside of the room).

**LATCH ASSEMBLY**

Prepare the Latch for assembly. Position the Latch and Latch Spring as shown and pass the assembly pin through the two parts.

**400 LATCH**  
FOR CYLINDRICAL  
& MORTISE LOCKS

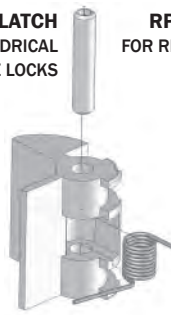

**RP LATCH**  
FOR RIM PANIC  
DEVICES

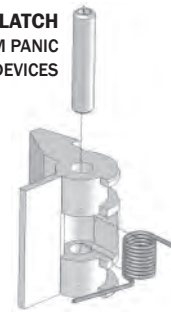

**(A) SWAP LATCHES**

At 5 (Below) you may switch out the standard Cylindrical/Mortise Latch for the RP (rim panic) Latch.

**Note:** RP Latch is NOT Fire Rated (it is Outdoor rated)

**RIGHT HAND ASSEMBLY**

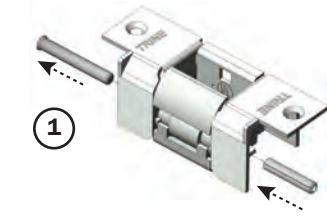

Disassemble the Back Cover and the solenoid of the Left Hand configured EN strike.

Using the Assembly Pin, push the Latch Pivot Pin out.

Take the Latch & Spring and the Slider Guard out of the frame.

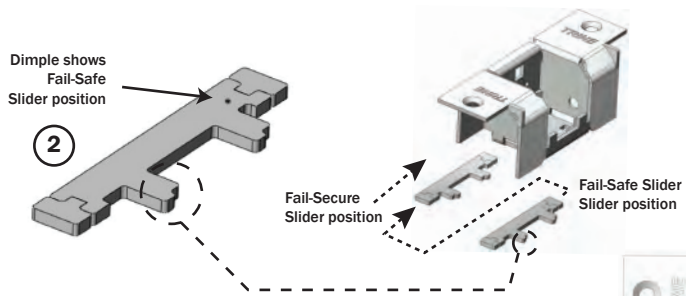

Insert the Slider as Fail-Secure or Fail-Safe position as shown.

Align the Slider with the pick guard ribs as shown.



Assemble the Slider Guard over the Slider.

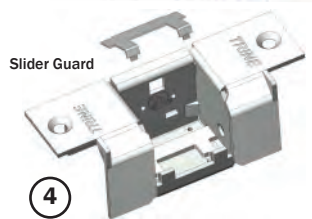

**(A) below**

Pass the long leg of the Spring through the rectangular hole on the frame and let the Latch assembly drop to position where all the pivot holes lines up.

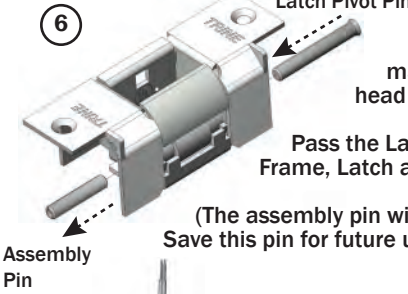
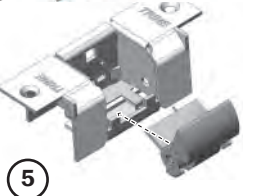

Insert the Latch Pivot Pin making sure that the flared pin head is towards the right as shown.

Pass the Latch Pivot Pin through the Frame, Latch and Spring.

(The assembly pin will fall off the opposite end. Save this pin for future use.)



Assemble the Solenoid and secure it with the solenoid Screw as shown.

Finish the assembly by installing the Cover and securing it with the two assembly Screws.

**LEFT HAND ASSEMBLY**

Disassemble the Back Cover and the solenoid of the Right Hand configured EN strike.

Using the Assembly Pin, push the Latch Pivot Pin out.

Take the Latch & Spring and the Slider Guard out of the frame.

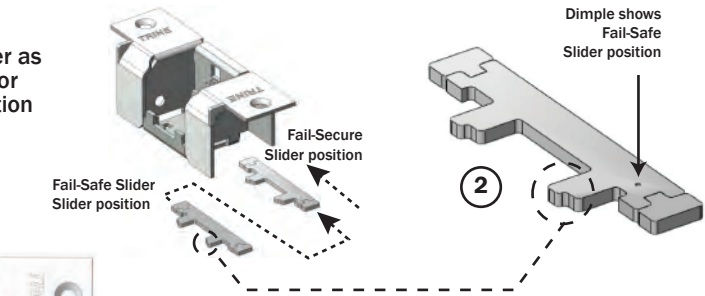

Insert the Slider as Fail-Secure or Fail-Safe position as shown.

Align the Slider with the pick guard ribs as shown.

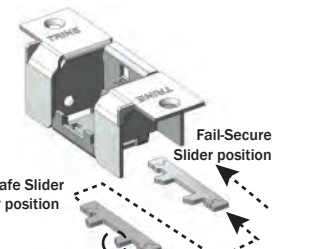

Assemble the Slider Guard over the Slider.

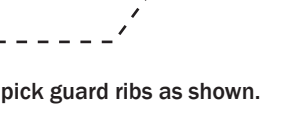

**(A) below**

Pass the long leg of the Spring through the rectangular hole on the frame and let the Latch assembly drop to position where all the pivot holes lines up.

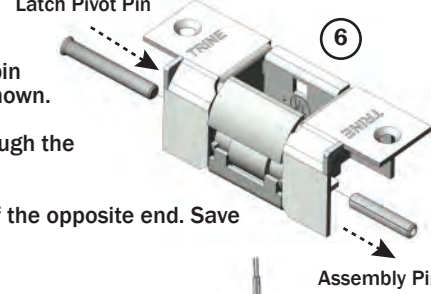

Insert the Latch Pivot Pin making sure that the flared pin head is towards the left as shown.

Pass the Latch Pivot Pin through the Frame, Latch and Spring.

(The assembly pin will fall off the opposite end. Save this pin for future use.)



Assemble the Solenoid and secure it with the solenoid Screw as shown.

Finish the assembly by installing the Cover and securing it with the two assembly Screws.

**9 ATTACH ELECTRIC STRIKE BODY TO EN800 OR EN850 FACEPLATE**

The completed electric strike body attaches to the rim panic EN800 or EN850 faceplate as shown here.

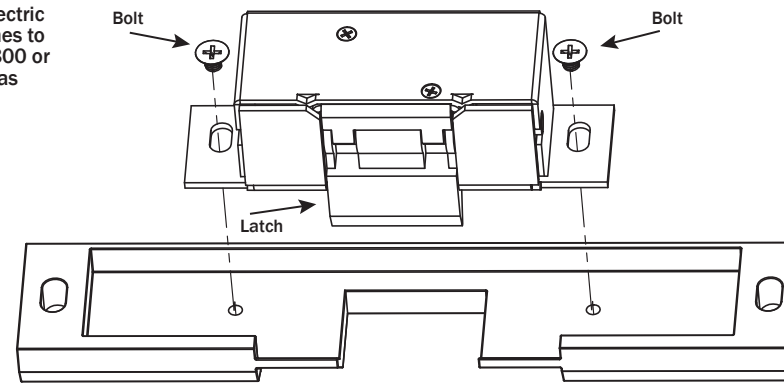

**Total Wiring Length Chart**

To Transformer	12V	24V
Up to 50 Ft	18AWG	20AWG
50 to 150 ft	16AWG	18AWG
150 to 300 ft	14AWG	16AWG
300 to 600 ft	12AWG	14AWG

Cont... Page 2 Door Handing Determination

The position of the Electric Strike in the door jamb will be the same for a right-handed door and a lefthanded door. For these installations, the Electric Strike position in the door jamb will be as shown in Figure 3.

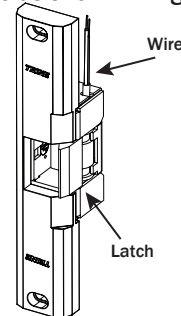

**Figure 3.**  
Position of Electric Strike for Right Hand Inswinging and Left Hand Outswinging Door

In a similar manner, the position of the Electric Strike in the door jamb will be the same for a lefthanded reverse bevel door and a right-handed door. For these installations, the Electric Strike position in the door jamb will be as shown in figure (4).

**Figure 4.**  
Position of Electric Strike for Left Hand Inswinging and Right Hand Outswinging Door

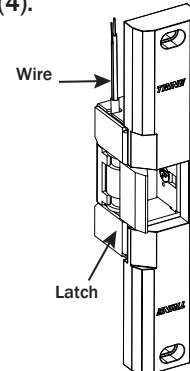

**NOTE**

The EN Electric Strike must be installed with coil assembly up (wiring toward top of unit). In this position, the Electric Strike will be locked without power, Fail Secure, or locked with power, Fail Safe action. Before performing Handing Procedure, view Electric Strike in up position (wire leads at top) to determine if a handing change is required.

wiring and Electric Strike wiring.

4. If required, run new wiring to door frame mounting hole. See figure 10 for typical wiring installations. Refer to wiring chart below for correct wire size. (Total wiring length includes routing to door-release push button).

**NOTE**

For DC operation, to obtain an audible signal when Electric Strike is energized, install buzzer type BZ-12 for 12VDC operation, or BZ-24 for 24VDC operation (purchased separately), as illustrated in figure 10. 5. Hold Electric Strike upright (wiring toward top) and determine if handing is required. If so, perform handing procedure.

6. Splice Electric Strike wiring to supply wiring. Secure with wire nuts (supplied).

7. For wood and aluminum door jambs, drill pilot holes for securing Electric Strike to door jamb. For steel and aluminum door jambs, secure Electric Strike to existing mounting tabs.

8. Install Electric Strike into door jamb and secure with flat head mounting screws.

9. Verify that door operates correctly when Electric Strike is energized and not energized.

**NOTE**

1. Rectifier can be located either between transformer and push button, or between push button and electric strike.  
2. Use either a silicon rectifier or a current regulating rectifier for converting the AC voltage at the transformer secondary to the DC for operating the electric strike.

**INSTALLATION PROCEDURE:**

- For new or replacement installation in wood or metal jambs.

1. Verify that voltage rating of Electric Strike is compatible with supply voltages of installation. Coil voltages are color coded.

WIRE LEAD	CODE/STRIPE
12AC	Blue/Orange Stripe
12DC	2 Orange Stripe
24AC	Blue/Black Stripe
24DC	2 Black Stripe

2. Using template supplied with Electric Strike, mark door jamb for cutout and screw holes.

**NOTE**

For proper installation, center line of latches must be aligned with center line of Electric Strike.

3. Prepare door frame (cut out jamb if required) for Electric Strike. Leave sufficient space for splicing between power supply

**Figure 10a. USING DC TRANSFORMER**

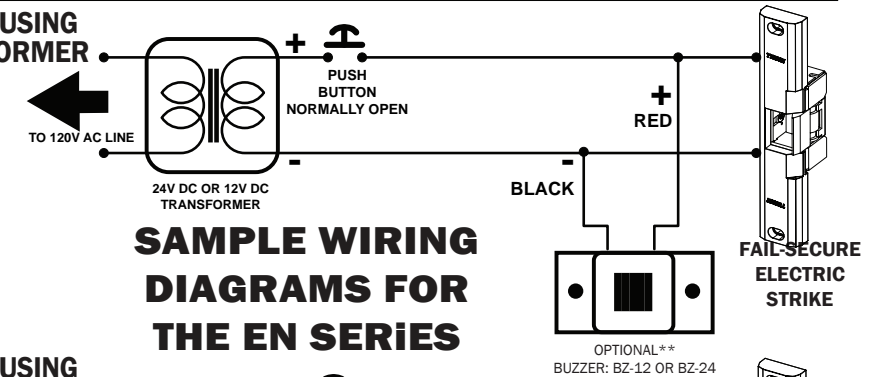

**Figure 10b. USING AC TRANSFORMER**

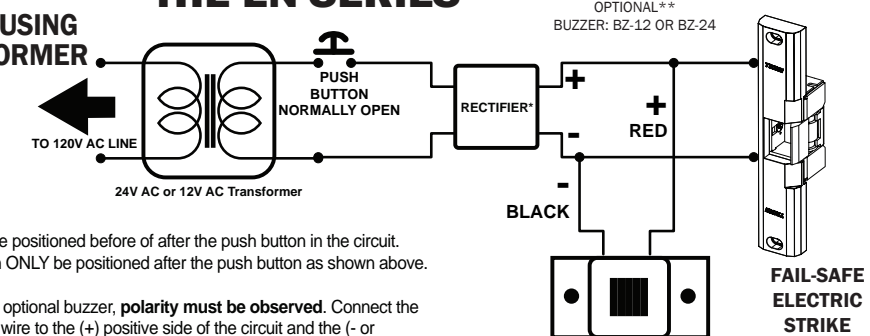

\* The rectifier can be positioned before or after the push button in the circuit. The LC module can ONLY be positioned after the push button as shown above.

\*\*\* When wiring the optional buzzer, polarity must be observed. Connect the (+ or RED) positive wire to the (+) positive side of the circuit and the (- or BLACK) negative side wire terminal to the negative side of the circuit.

OPTIONAL\*\* BUZZER: BZ-12 OR BZ-24 BZ-6 FOR LC VERSION