

# Specialty Head and Jamb Protection Ligature-Resistant Gasketing (ZAG option)



Note: A = Aluminum  
AA = Clear Anodized  
B = Bronze  
D = Dark Bronze Anod.  
FS = Intumescent  
G = Gold Anodized  
S-Bk = Silicone, Black  
S-Br = Silicone, Brown  
S-CI = Silicone, Clear  
S-Gy = Silicone, Gray  
S-Wh = Silicone, White  
ZAG = Ligature-Resistant

**Z**ero offers a **ligature-resistant** option to prevent gasketing from being used for other than intended purposes, including harming self or others. The rubber in our **patented** ligature-resistant gasketing is scored before insertion into aluminum extrusions, allowing normal function for its specified purpose but designed to break into pieces if removed from the extrusion for any reason.

Applications for ligature-resistant gasketing include correctional facilities and mental health facilities.

Gasketing ordered with this patented feature is installed as usual, with no special handling required. In addition to the applications shown below, the ligature-resistant option can be supplied on request with most other Zero gasketing. To order, add **ZAG** to the part number.

## Applications

Correctional facilities, hospitals, psychiatric and mental health facilities.

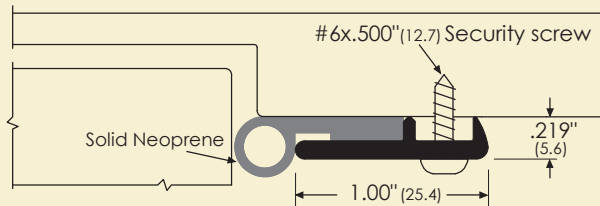
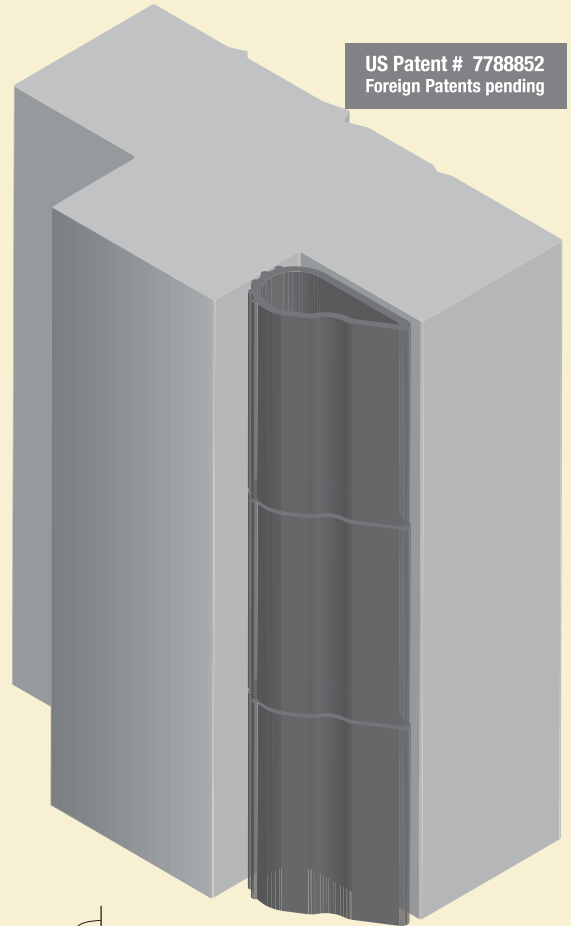

#328AA-ZAG  
#328B-ZAG  
#328D-ZAG  
#328G-ZAG  
ZERO Compress-O-Matic®

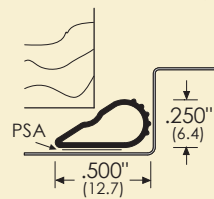
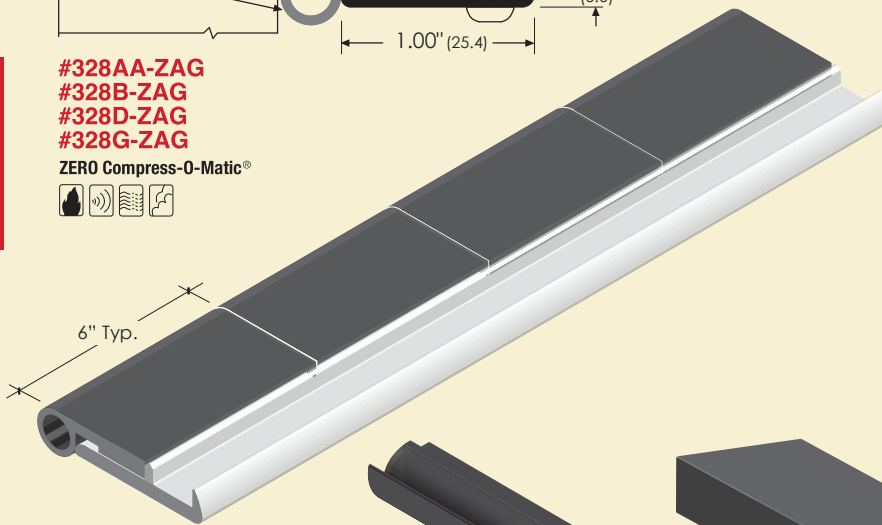

#188S-Bk-ZAG  
#188S-Br-ZAG  
#188S-CI-ZAG  
#188S-Gy-ZAG  
#188S-Wh-ZAG  
#188FS-ZAG  
ZERO Compress-O-Matic®

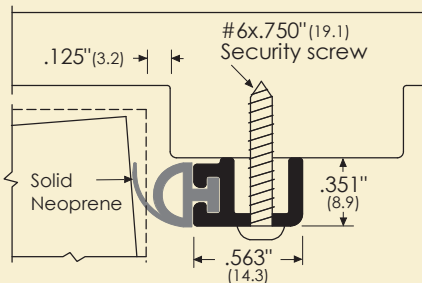

#485A-ZAG  
#485D-ZAG  
#485G-ZAG  
ZERO Compress-O-Matic®

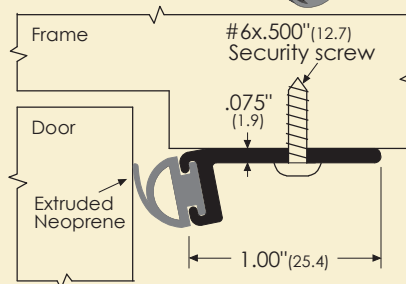

#99A-ZAG  
#99D-ZAG  
ZERO Compress-O-Matic®

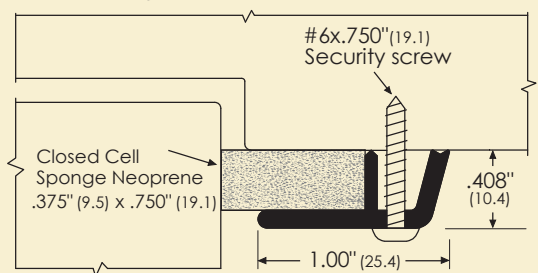

#318AA-ZAG  
#318D-ZAG  
#318G-ZAG