

Full Concealed

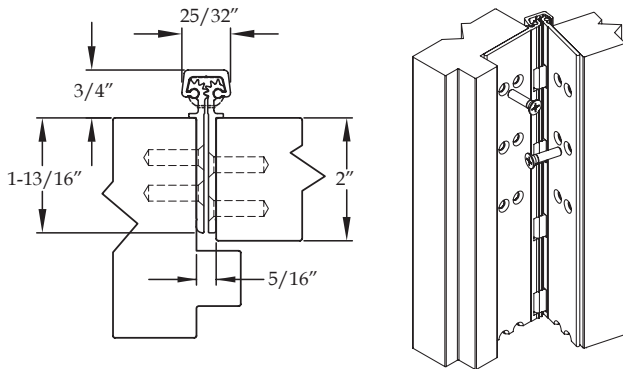

A270 HD A270 LL

Standard Features

- Full concealed, heavy duty
- No door inset, flush mount
- For use on 2" thick door
- 48" door width maximum
- 450 lbs. door weight maximum
- "LL" model for doors up to 1,000 lbs. (lead-lined staggered hole pattern)
- **Fasteners:** 12-24 x 7/8" undercut self-drilling, thread-forming tek machine screws
- **Standard lengths:** 79", 83", 85", 95" and 120"
- **Finishes:** Clear, dark bronze and black anodized
- **Fire Rating**
 - Approved for use on metal swinging type fire doors rated up to and including 90 minutes (Specify "FR" option for 3 hour rating)
 - Approved for use on wood swinging type fire doors rated up to and including 60 minutes (Specify "FR" option for 90 minute rating)

Options Available

- See pages F-6 – F-8 for option availability and details

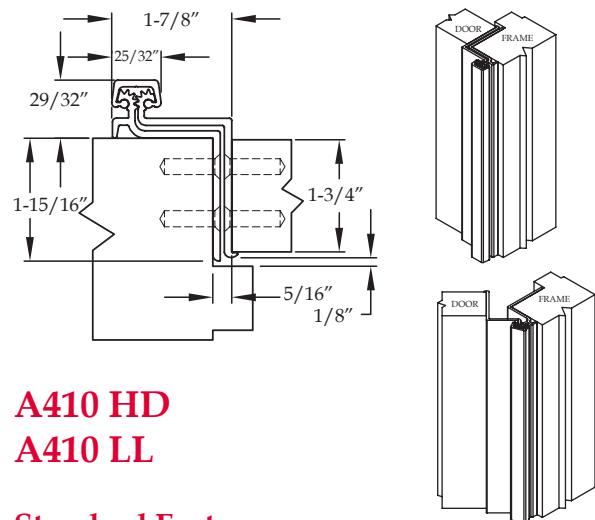

A410 HD A410 LL

Standard Features

- Full concealed, heavy duty
- No door inset, flush mount
- Swing clear application
- Door edge protection lip
- For use on 1-3/4" thick door, square edged only
- 48" door width maximum
- 450 lbs. door weight maximum
- "LL" model for doors up to 1,000 lbs. (lead-lined staggered hole pattern)
- **Fasteners:** 12-24 x 7/8" undercut self-drilling, thread-forming tek machine screws
- **Standard lengths:** 79", 83", 85", 95" and 120"
- **Finishes:** Clear, dark bronze and black anodized
- **Fire Rating**
 - Approved for use on metal swinging type fire doors rated up to and including 90 minutes (Specify "FR" option for 3 hour rating)
 - Approved for use on wood swinging type fire doors rated up to and including 60 minutes (Specify "FR" option for 90 minute rating)

Options Available

- See pages F-6 – F-8 for option availability and details



A410HD / A410LL - ALUMINUM GEARED HINGE, SWING CLEAR, NO INSET, FLUSH MOUNT

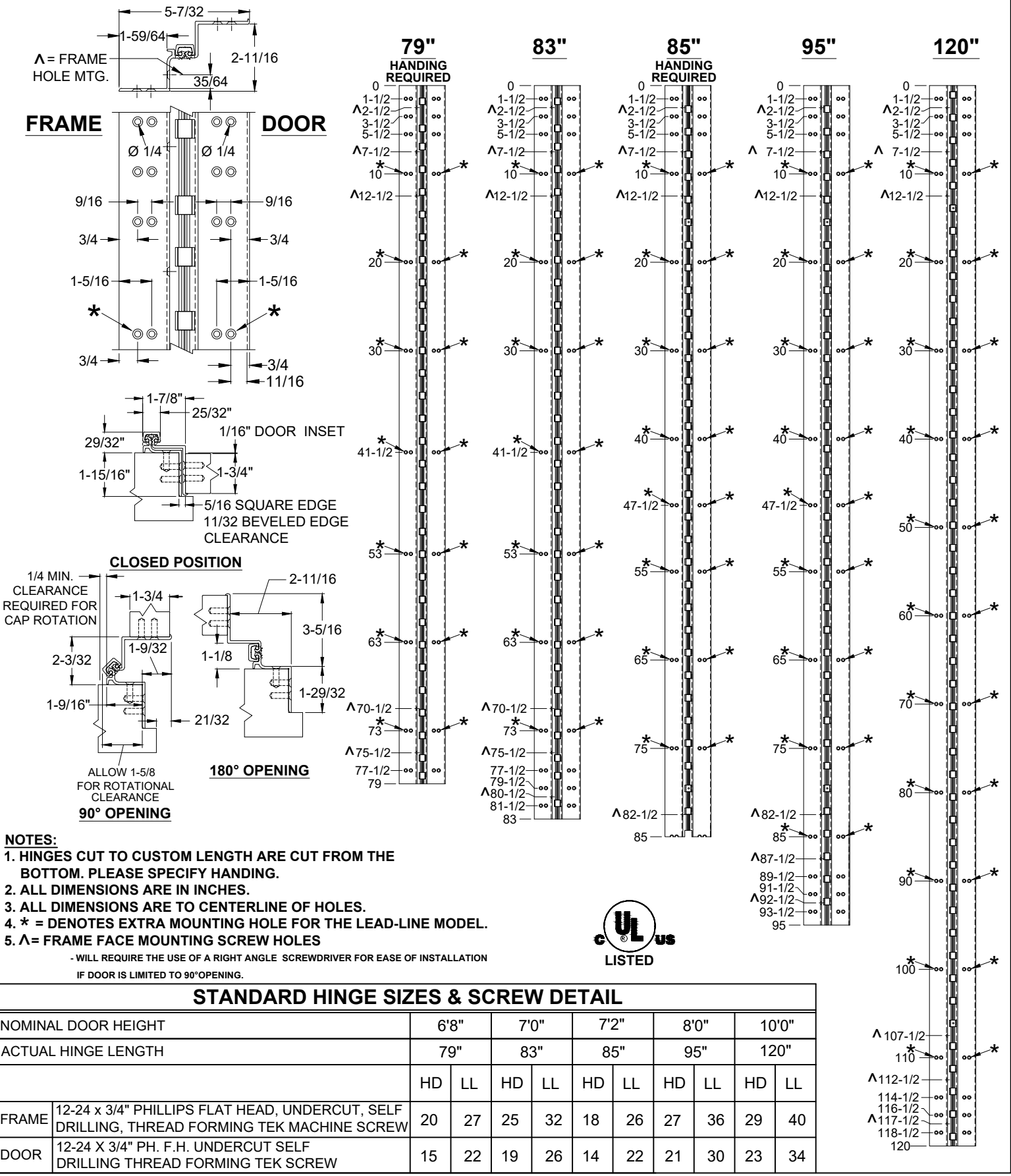

- NOTES:**
- HINGES CUT TO CUSTOM LENGTH ARE CUT FROM THE BOTTOM. PLEASE SPECIFY HANDING.
 - ALL DIMENSIONS ARE IN INCHES.
 - ALL DIMENSIONS ARE TO CENTERLINE OF HOLES.
 - * = DENOTES EXTRA MOUNTING HOLE FOR THE LEAD-LINE MODEL.
 - Δ = FRAME FACE MOUNTING SCREW HOLES
- WILL REQUIRE THE USE OF A RIGHT ANGLE SCREWDRIVER FOR EASE OF INSTALLATION IF DOOR IS LIMITED TO 90° OPENING.



STANDARD HINGE SIZES & SCREW DETAIL

NOMINAL DOOR HEIGHT		6'8"		7'0"		7'2"		8'0"		10'0"	
ACTUAL HINGE LENGTH		79"		83"		85"		95"		120"	
		HD	LL	HD	LL	HD	LL	HD	LL	HD	LL
FRAME	12-24 x 3/4" PHILLIPS FLAT HEAD, UNDERCUT, SELF DRILLING, THREAD FORMING TEK MACHINE SCREW	20	27	25	32	18	26	27	36	29	40
DOOR	12-24 X 3/4" PH. F.H. UNDERCUT SELF DRILLING THREAD FORMING TEK SCREW	15	22	19	26	14	22	21	30	23	34



www.abhmf.com
 E-mail: abhinfo@abhmf.com
 Architectural Builders Hardware Mfg., Inc.
 1222 Ardmore Ave., Itasca, IL 60143
 630.875.9900; FAX 800.9FAXABH (932.9224)

© 2021 ABH Mfg., Inc.
 printed in USA

A410 ALUMINUM GEARED HINGE

A410-ALUMINUM GEARED HINGE-06.DWG

UL FIRE RATED STUDS FOR INSTALLATION FULL CONCEALED ALUMINUM GEARED HINGES

MODELS A110HD/LL, A111HD/LL, A140HD/LL, A150HD/LL, A160HD/LL, A240HD/LL, A260HD/LL
A270HD/LL, A280HD/LL & A410HD/LL

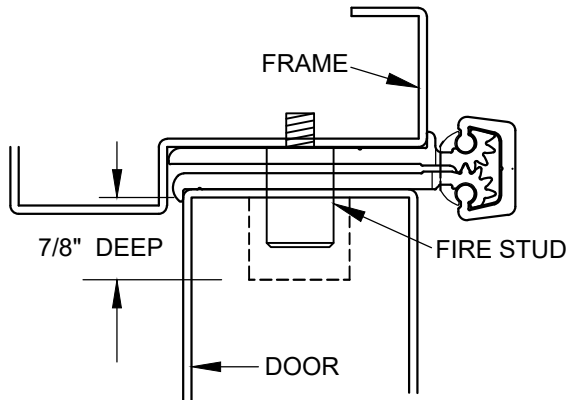

**DOOR SHOWN CLOSED WITH FIRE STUD IN PLACE
USING MODEL A240HD HINGE**

NOTES:

1. INSTALL HINGE PER INSTALLATION INSTRUCTIONS FOR EACH MODEL.
2. FOR THE FRAME SIDE - DRILL AND TAP (4) 12-24 HOLES FOR FIRE STUDS.
3. FOR THE DOOR SIDE - DRILL (4) 3/4" DIA. HOLES IN THE DOOR TO CORRESPOND TO THE STUD HOLES IN THE FRAME SIDE.
4. INSERT STUDS IN THE FOUR (4) TAPPED FRAME HOLES, TIGHTEN SECURELY.
5. SLOWLY CLOSE DOOR MAKING SURE THAT THE STUDS ARE PROPERLY ALIGNED.
6. MINOR INTERFERENCE CAN BE TAKEN CARE OF WITH A ROUND METAL FILE.

DIMENSION					
"A" HINGE LENGTH	79"	83"	85"	95"	120"
"B"	12"	12"	12"	12"	12"
"C"	25-3/8"	27-3/8"	28-3/8"	32-3/8"	42-1/2"
"D"	53-5/8"	55-5/8"	56-5/8"	62-5/8"	77-1/2"
"E"	67"	71"	73"	83"	108"

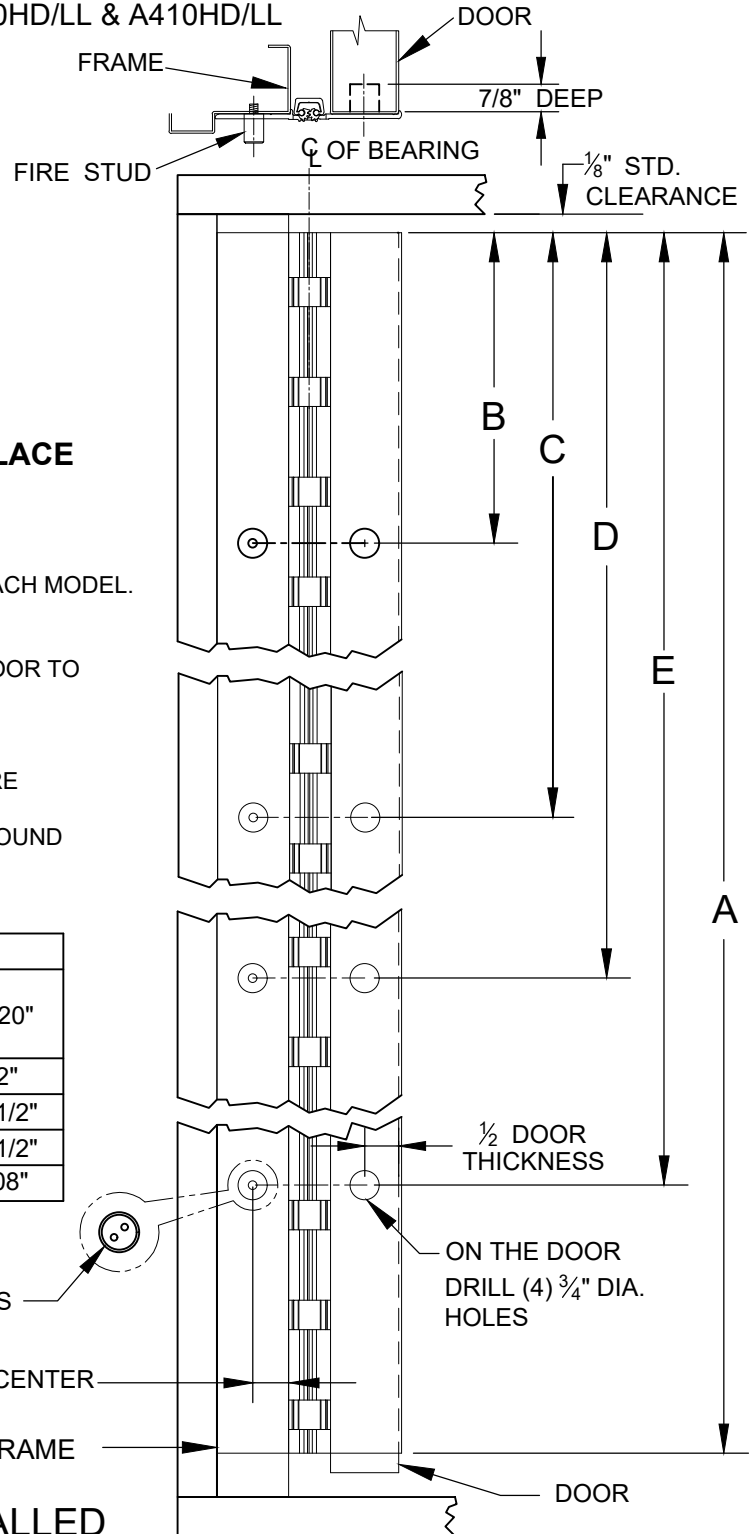

DOOR SHOWN OPEN 180°

ON THE FRAME, DRILL AND TAP (4) 12-24 HOLES

1/2 THE DOOR THICKNESS + 1/32" FROM CENTER OF HOLE TO EDGE OF FRAME

1/2 DOOR THICKNESS

ON THE DOOR DRILL (4) 3/4" DIA. HOLES

**ALL FOUR (4) STUDS MUST BE INSTALLED
TO COMPLY WITH U.L. RATING**

FIRE STUD - FULL CONCEALED-03.DWG



www.abhmf.com
E-mail: abhinfo@abhmf.com
Architectural Builders Hardware Mfg., Inc.
1222 Ardmore Ave., Itasca, IL 60143
630.875.9900; FAX 800.9FAXABH (932.9224)

© 2021 ABH Mfg., Inc.
printed in USA

**FIRE STUD -
FULL CONCEALED**

PAGE 1 OF 1
REVISED 11-22-21

POWDER COAT MASKING

**MUST HANG PART
AS SHOWN TO PREVENT
PART FROM BENDING
BY THE CUTOUT**

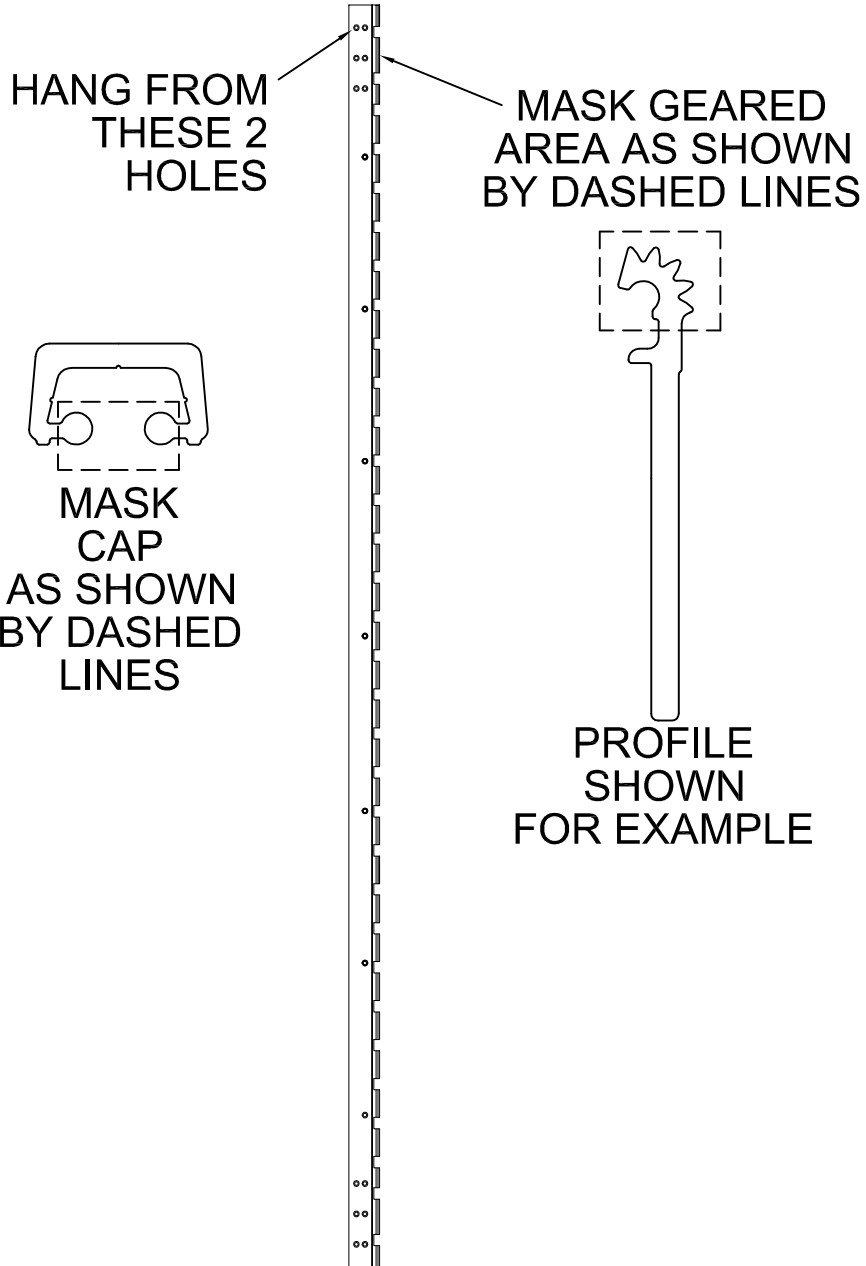

® www.abhmfg.com
E-mail: abhinfo@abhmfg.com
Architectural Builders Hardware Mfg., Inc.
1222 Ardmore Ave., Itasca, IL 60143
630.875.9900; FAX 800.9FAXABH (932.9224)

POWDER COAT MASKING-00.DWG

POWDER COAT MASKING

© 2008 ABH Mfg., Inc.
printed in USA

PAGE 1 OF 1
ISSUED 12-15-08

INSTALLATION INSTRUCTIONS FOR FULL CONCEALED HINGES

A110HD/LL, A111HD/LL, A130HD, A135HD, A140HD/LL, A150HD/LL, A160HD/LL
A240HD/LL, A260HD/LL, A270HD/LL, A280HD/LL & A410HD/LL

- A. All uncut standard length hinges are non-handed and can be used for right or left hand doors.
- B. Standard length hinges are supplied slightly shorter than nominal door height to accommodate threshold and carpeting clearances.

CUTTING THE HINGE TO FIT

- Keep hinge in the closed position
- Determine **HANDING** if required. Not all hinges will become handed after cutting.
- Cut one end of the hinge only. Cut end will be installed at the bottom (Six-hole pattern remains at the top)
- Use a Metal Cutting Saw cut through the gear cap first.

Note: If cut length interferes with a set screw bearing remove it and switch it with a plain bearing above the cut location.

FRAME PREP

With the hinge in the open position

1. Locate the top of the hinge 1/8" below the header

With the frame leaf flange tight against the frame

2. Mark or Center Punch hole locations

Note: If using wood screws drill a 5/32" pilot hole

DO NOT ATTACH HINGE TO FRAME AT THIS TIME

ATTACH THE HINGE TO THE DOOR

4. Position Door Leaf on door. Door leaf alignment flange or door leaf lip must be seated against door edge.
5. Align the top end of the hinge to be absolutely flush with the top of the door.
6. Mark or Center Punch hole locations
7. Using the provided Self Drilling/Thread Forming Screws and the proper drive bit please proceed to attach the hinge to the door

Note: If using wood screws drill a 5/32" pilot hole.

ATTACHING DOOR TO FRAME

8. Position door 90 degrees to frame
9. Shim door to the proper height to line up the screw holes in hinge frame leaf with the marks at the top of the frame.
10. Install two screws at the top of the hinge to hold in place
11. Remove shim and align the remaining holes. Install two additional screws in the middle and at the bottom.
12. Check door for proper swing and clearance before installing remaining screws, making necessary adjustments.
13. Install the remaining fasteners after any adjustments are made.

REINFORCING AND RIVNUTS

- No reinforcing is necessary except on extremely high-frequency, extremely heavy or extra-wide doors.
- Rivnuts are recommended for use in the frame when the door exceeds 450lbs.

Note: RIVNUTS are **not** to be used with Fire Rated Hinges

PAIRS OF DOORS WITH MULLIONS

- If the mullion is between the doors, install as single doors.
- If the mullion is behind the doors, install as a double doors.

GROUT/SLUSHED-IN FRAMES

It is recommended that a mudguard be installed behind the frame for ease of installation. Do not use self-drill screws with grouted steel frames without a mudguard. If no mudguard has been used, drill holes through frame and remove grout for screw clearances. Do not oversize hole.

SCREW DETAIL	
FRAME	12-24 x 3/4" PHILLIPS FLAT HEAD, UNDERCUT, SELF DRILLING, THREAD FORMING TEK MACHINE SCREW
DOOR	12-24 x 3/4" PHILLIPS FLAT HEAD, UNDERCUT, SELF DRILLING, THREAD FORMING TEK MACHINE SCREW

Note: #12 x 1-1/2" FLAT HEAD UNDERCUT WOOD SCREWS AVAILABLE UPON REQUEST

The following actions will void any warranty, expressed or implied.

- Failure to Install the hinge according to ABH's specifications and requirements
- Use of Fasteners other than those supplied with the hinge.
- Unauthorized field modifications including removing any of the bearings, altering the original finish or painting the hinge.

ABH
MANUFACTURING INC.

www.abhmfg.com
E-mail: abhinfo@abhmfg.com
Architectural Builders Hardware Mfg., Inc.
1222 Ardmore Ave., Itasca, IL 60143
630.875.9900; FAX 800.9FAXABH (932.9224)

© 2020 ABH Mfg., Inc.
printed in USA

FM INSTALLATION-05.DWG
FULL CONCEALED
INSTALLATION
INSTRUCTIONS
PAGE 1 OF 1
REVISED 9-17-20

ABH EZ CONNECT WIRE COLOR & POSITION STANDARD FOR MOLEX™ MICRO-FIT 3.0 CONNECTOR

(TERMINAL INSERTION END SHOWN)

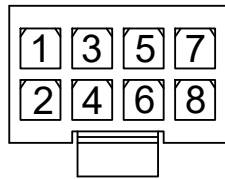

- 1: BLACK
- 2: RED
- 3: WHITE
- 4: GREEN
- 5: ORANGE
- 6: BLUE
- 7: BROWN
- 8: YELLOW

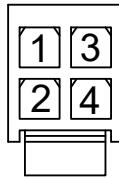

- 1: VIOLET
- 2: GREY
- 3: PINK
- 4: TAN

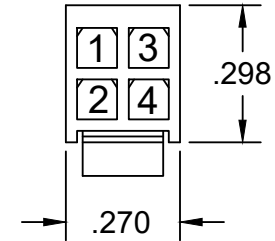
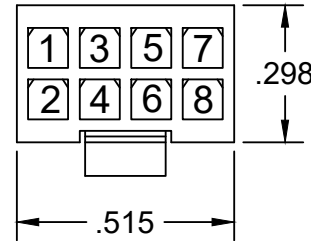

NOTE:
ABH CAN MATCH ANY MANUFACTURERS
WIRE COLOR POSITION

- AVAILABLE ON**
- STAINLESS STEEL CONTINUOUS HINGE
 - ALUMINUM CONTINUOUS HINGES
 - POWER TRANSFER UNITS
 - PIVOTS
 - ABH MORTISE LOCKS

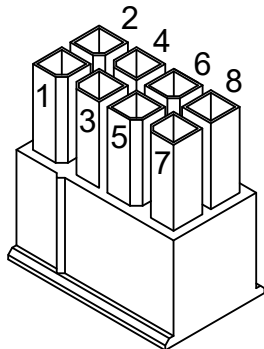

8-PIN HOUSING
WIRE POSITION

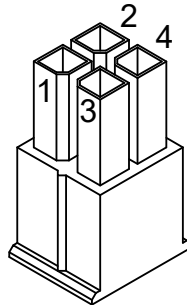

4-PIN HOUSING
WIRE POSITION

CONNECTORS COMPATIBLE WITH CONNECTORS
ON ASSA ABLOY PRODUCTS*

* BRAND NAMES ARE TRADEMARKS OR REGISTERED TRADEMARKS OF THEIR RESPECTIVE COMPANIES

PT1000EZ WIRE COLOR-ASSA ABLOY-06.DWG



www.abhmfg.com
E-mail: abhinfo@abhmfg.com
Architectural Builders Hardware Mfg., Inc.
1222 Ardmore Ave., Itasca, IL 60143
630.875.9900; FAX 800.9FAXABH (932.9224)

© 2022 ABH Mfg., Inc.
printed in USA

EZ CONNECT WIRE COLOR & POSITION
STANDARD FOR MOLEX™ CONNECTOR

PAGE 1 OF 1
REVISED 03-15-22



ABH Manufacturing Inc.
1222 Ardmore Avenue
Itasca, IL 60143
Ph: (630)875-9900 Fax: (800) 932-9224
www.abhmfg.com

ANSI/BHMA A156.26-2017 Certified Continuous Hinges

Edge Mounted-Barrel Type-Stainless Steel-Grade 1

ABH Model Number(s): A500, A505, A515

Edge Mounted-Gear Type-Aluminum-Grade 1

ABH Model Number(s): A110(HD/LL), A110WT(HD/LL), A111(HD/LL),
A111WT(HD/LL), A130HD, A140(HD/LL), A150(HD/LL), A160(HD/LL),
A240(HD/LL), A260(HD/LL), A270(HD/LL), A410(HD/LL)

Full Surface Mounted-Barrel Type-Stainless Steel-Grade 1

ABH Model Number(s): A502, A512

Full Surface Mounted- Gear Type- Aluminum-Grade 1

ABH Model Number(s): A210HD, A570HD, A571HD

Half-Surface Mounted-Barrel Type-Stainless Steel-Grade 1

ABH Model Number(s): A503

Half-Surface Mounted- Gear Type- Aluminum-Grade 1

ABH Model Number(s): A211HD, A213HD, A450HD, A460HD, A530HD, A540HD,
A550HD

Half Mortise Mounted-Barrel Type-Stainless Steel-Grade 1

ABH Model Number(s): A504, A506

Half Mortise Mounted- Gear Type- Aluminum-Grade 1

ABH Model Number(s): A520HD

Swing Clear Edge Mounted-Barrel Type-Stainless Steel-Grade 1

ABH Model Number(s): A510, A511, A526, A529

Swing Clear Edge Mounted- Gear Type- Aluminum-Grade 1

ABH Model Number(s): A410(HD/LL), A211HD

HD-denotes Heavy Duty Hinge

LL-denotes Heavy Duty hinge with extra screw holes to accommodate the lead in lead lined doors

Door Clearance Chart Squared Edge

Single Door - Squared Edged							
Hinge Model		Hinge Thickness	+	Lock Side Clearance	+	*Frame Irregularity (OPTIONAL)	= Square Edged Door Undersized (Single)
Full Concealed	A110, A110WT, A111 A111WT, A120, A140, A150, A160, A240, A260, A270, A410	5/16"	+	1/8"	+	1/32"	= 15/32"
	A130, A135	13/16"	+	1/8"	+	1/32"	= 3 1/32"
Half Surface	A211, A213, A450, A460, A520, A530, A540, A550	3/16"	+	1/8"	+	1/32"	= 1 1/32"
Full Surface	A210, A570, A571, A575	1/16"	+	1/8"	+	1/32"	= 7/32"

Single Door

Pair of Doors

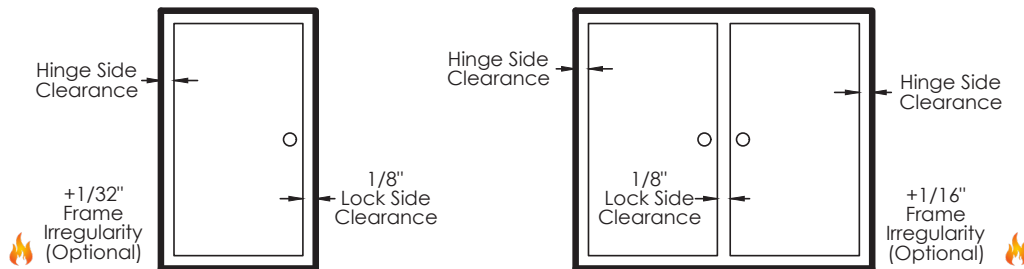

Pair of Doors - Squared Edged							
Hinge Model		Hinge Thickness (Pair)	+	Lock Side Clearance	+	*Frame Irregularity (OPTIONAL)	= Square Edged Door Undersized (Pair)
Full Concealed	A110, A110WT, A111 A111WT, A120, A140, A150, A160, A240, A260, A270, A410	5/8"	+	1/8"	+	1/16"	= 13/16"
	A130, A135	1-5/8"	+	1/8"	+	1/16"	= 1-13/16"
Half Surface	A211, A213, A450, A460, A520, A530, A540, A550	1/4"	+	1/8"	+	1/16"	= 7/16"
Full Surface	A210, A570, A571, A575	1/8"	+	1/8"	+	1/16"	= 5/16"

* 1/16" Frame Irregularity Allowance, Optional and included in all Total Door Undersize for single and pairs of doors

Frame irregularity not permitted by NFPA80

Door Clearance Chart Beveled Edge

Single Door - Beveled Edged										
Hinge Model		Hinge Thickness	+	Lock Side Clearance	+	* Frame Irregularity (OPTIONAL)	+	Beveled Door Clearance	=	Beveled Edged Door Undersized (Single)
Full Concealed	A110, A110WT, A111, A111WT, A120, A140, A150, A160, A240, A260, A270, A410	5/16"	+	1/8"	+	1/32"	+	1/32"	=	1/2"
	A130, A135	13/16"	+	1/8"	+	1/32"	+	1/32"	=	1"
Half Surface	A211, A213, A450, A460, A520, A530, A540, A550	3/16"	+	1/8"	+	1/32"	+	1/32"	=	3/8"
Full Surface	A210, A570, A571, A575	1/16"	+	1/8"	+	1/32"	+	N/A	=	7/32"

Single Door

Pair of Doors

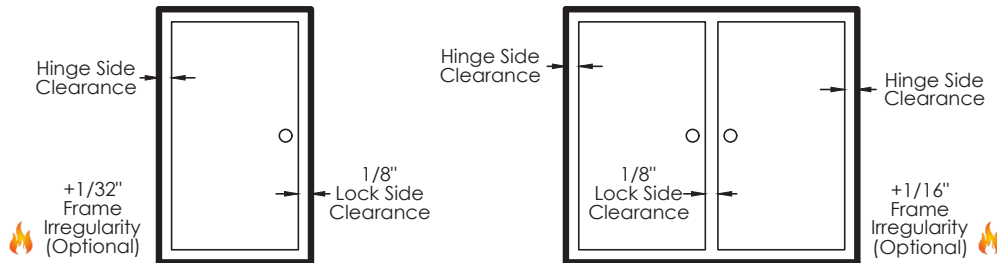

Pair of Doors - Beveled Edged										
Hinge Model		Hinge Thickness (Pair)	+	Lock Side Clearance	+	* Frame Irregularity (OPTIONAL)	+	Beveled Door Clearance	=	Beveled Edged Door Undersized (Pair)
Full Concealed	A110, A110WT, A111, A111WT, A120, A140, A150, A160, A240, A260, A270, A410	5/8"	+	1/8"	+	1/16"	+	1/16"	=	7/8"
	A130, A135	1-5/8"	+	1/8"	+	1/16"	+	1/16"	=	1-7/8"
Half Surface	A211, A213, A450, A460, A520, A530, A540, A550	1/4"	+	1/8"	+	1/16"	+	N/A	=	7/16"
Full Surface	A210, A570, A571, A575	1/8"	+	1/8"	+	1/16"	+	N/A	=	5/16"

* 1/16" Frame Irregularity Allowance, Optional and included in all Total Door Undersize for single and pairs of doors

Frame irregularity not permitted by NFPA80